

START

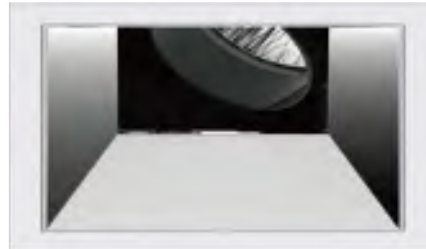

Adjustable

SQUARE
Downlight



Fixed



Wall Washer



ROUND
Downlight



START

Downlight

One light engine with various accessories
Easy to specify, Easy to manage stock
Easy to install and adjust, Easy to change reflector

START Series
DOWNLIGHT

Light engines

SRA
round adjustable/
downlight



SSA
square adjustable/
downlight



SRF
round fixed/
downlight



SSF
square fixed/
downlight

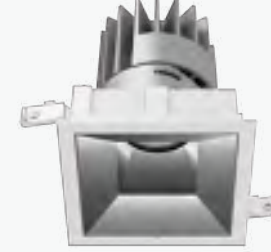

SRW
round wallwasher/
wallwasher floor

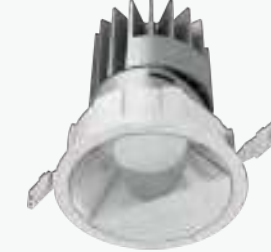

SSW
square wallwasher/
wallwasher floor



Cutout Diameter(mm)

Φ45 Φ68 Φ100 Φ125 Φ150

45x45 68x68 100x100 122x122 147x147

Φ100 Φ125 Φ150

100x100 122x122 147x147

Φ100 Φ125 Φ150

100x100 122x122 147x147

Trim Diameter(mm)

SRA45 SRA68 SRA100 SRA125 SRA150

SSA45 SSA68 SSA100 SSA125 SSA150

SRF100 SRF125 SRF150

SSF100 SSF125 SSF150

SRW100 SRW125 SRW150

SSW100 SSW125 SSW150

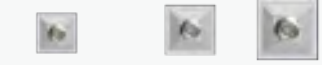
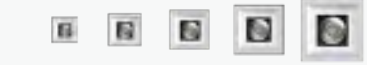

H:60 H:98 H:130/157 H:157 H:188

H:60 H:98 H:130/157 H:157 H:188

H:130/157 H:157 H:188

H:130/157 H:157 H:188

H:130/157 H:157 H:188

H:130/157 H:157 H:188

Height(mm)



Power

Luminous Flux

4W	7.5W	13W/18W	18W	25W
350Lm	600Lm	1200Lm 1700Lm	1600Lm	2400Lm
	11W	25W	25W	38W
	800Lm	2200Lm	2200Lm	3200Lm

4W	7.5W	13W/18W	18W	25W
350Lm	600Lm	1200Lm 1700Lm	1600Lm	2400Lm
	11W	25W	25W	38W
	800Lm	2200Lm	2200Lm	3200Lm

13W/18W	18W	25W
1100Lm/1500Lm	1500Lm	2100Lm
25W	25W	38W
1900Lm	2100Lm	2900Lm

13W/18W	18W	25W
1100Lm/1500Lm	1500Lm	2100Lm
25W	25W	38W
1900Lm	2100Lm	2900Lm

13W/18W	18W	25W
750Lm	800Lm	1000Lm
25W	25W	38W
1000Lm	1100Lm	1400Lm

13W/18W	18W	25W
750Lm	800Lm	1000Lm
25W	25W	38W
1000Lm	1100Lm	1400Lm

Beam Angle

10° 40° 50°
(only SRA68)

10° 40° 50°
(only SSA68)

35° 50°

35° 50°

Asymmetric optical distribution

Asymmetric optical distribution

Colour Temperature

Standard	Option
3000K	2700K
4000K	5000K

Standard	Option
3000K	2700K
4000K	5000K

Standard	Option
3000K	2700K
4000K	5000K

Standard	Option
3000K	2700K
4000K	5000K

Standard	Option
3000K	2700K
4000K	5000K

Standard	Option
3000K	2700K
4000K	5000K

CRI

Standard	Option
CRI>90	CRI>83

Standard	Option
CRI>90	CRI>83

Standard	Option
CRI>90	CRI>83

Standard	Option
CRI>90	CRI>83

Standard	Option
CRI>90	CRI>83

Standard	Option
CRI>90	CRI>83

LED Driver

Standard	Option
ON-OFF	Phase DIM 1-10V DIM DALI DIM

Standard	Option
ON-OFF	Phase DIM 1-10V DIM DALI DIM

Standard	Option
ON-OFF	Phase DIM 1-10V DIM DALI DIM

Standard	Option
ON-OFF	Phase DIM 1-10V DIM DALI DIM

Standard	Option
ON-OFF	Phase DIM 1-10V DIM DALI DIM

Standard	Option
ON-OFF	Phase DIM 1-10V DIM DALI DIM

Trimless Version



Secondary Reflector

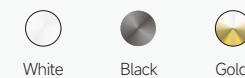
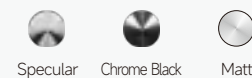

Anti-glare Accessory



Decoration Accessory
Colour film

Adjustable

Fixed

Wall Washer

Adjustable

Fixed

Wall Washer



Trimless



Trimless

START

Adjustable

Five sizes with LED wattages 4W-38W.
20°, 40°, and 50° beam angles are available
10° beam angle is optional for SRA68.
30° tilt and 355° rotation.

Fixed

A combination of deep recessed
secondary reflector and soft
lens creates visual comfort

Wall Washer

Asymmetric wall washer reflector
evenly illuminates walls

START Series
DOWNLIGHT

Adjustable

Smart mechanical design features precise angle alignment.
Artistical style meets architectural requirement.
Fixing screws can be rotated to match ceiling with different thickness.



Easy to Adjust

Precision engineered adjustment mechanism achieves accurate angle alignment.

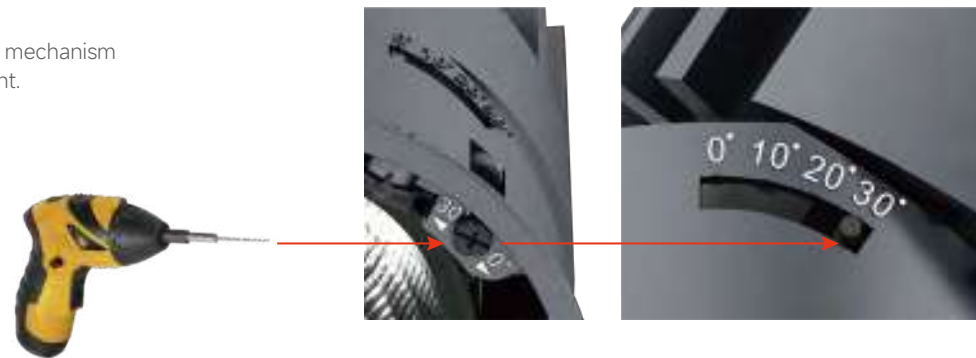

Intelligent mechanical design creates easy adjustment and precise alignment.

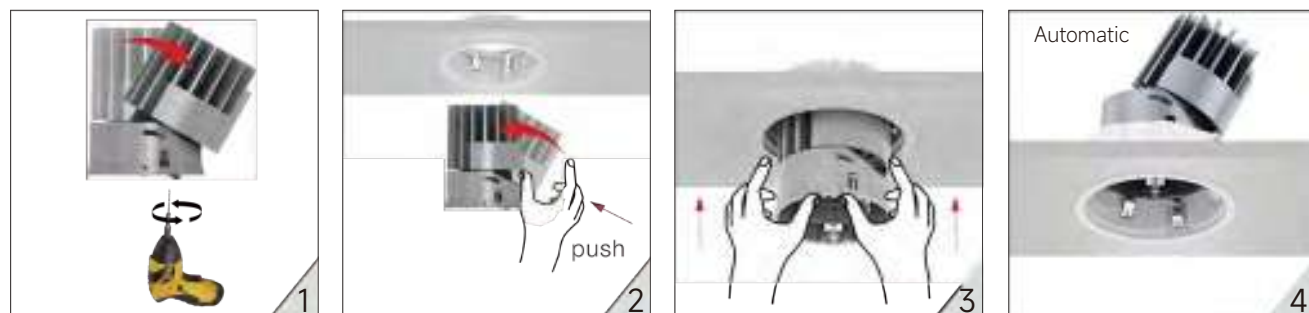

Technology Presents Arts

Ultra-narrow trim design leaves no flange between the secondary reflector and trim, meeting neat ceiling requirement.



Creative Ceiling Treatment

Installed easily and securely in the ceiling, using two screw fixing mechanisms.
Applying to 12-25mm thickness ceiling and to 1-12mm thickness ceiling with a fallen clip.

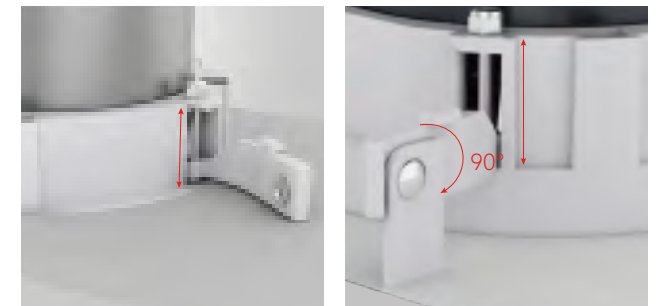

fit for ceiling thickness 12mm to 25mm

fit for ceiling thickness 1mm to 12mm

Installation





One light engine with various accessories



SRA | round adjustable/downlight



SSA | square adjustable/downlight

Trimless

Standard



Round-Adjustable



Square-Adjustable



Round-Adjustable



Square-Adjustable



Round-Fixed



Square-Fixed



Round-Fixed



Square-Fixed



(Only of Strat 100 Round)

Round-Wall Washer

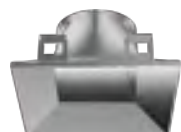

Square-Wall Washer



Round-Wall Washer



Square-Wall Washer

Secondary Reflector



Specular



Chrome Black



White



Matt



Black



Gold

Trimless Round



Trimless Square

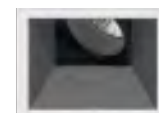
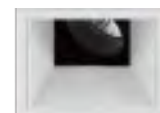
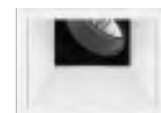
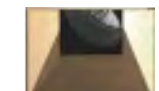
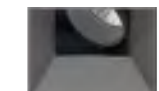
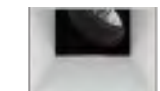
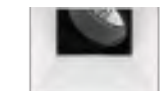

START Series
DOWNLIGHT / Adjustable

Meticulous to detail
Interchangeable design
Best optics control
Guarantee maximal eye comfort

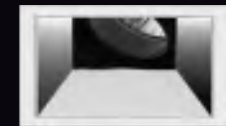
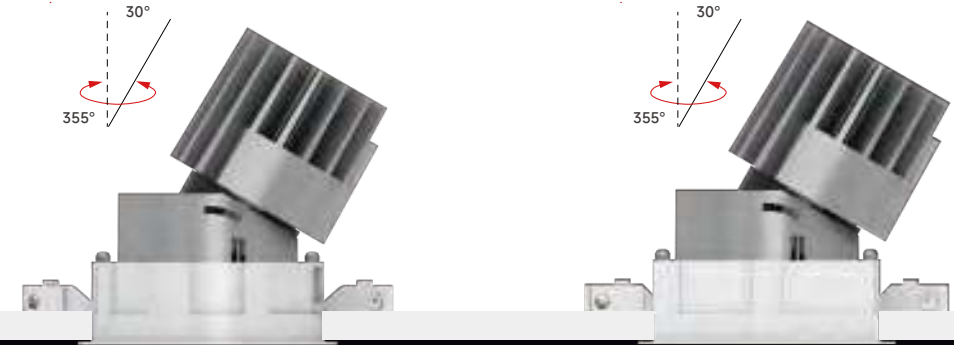
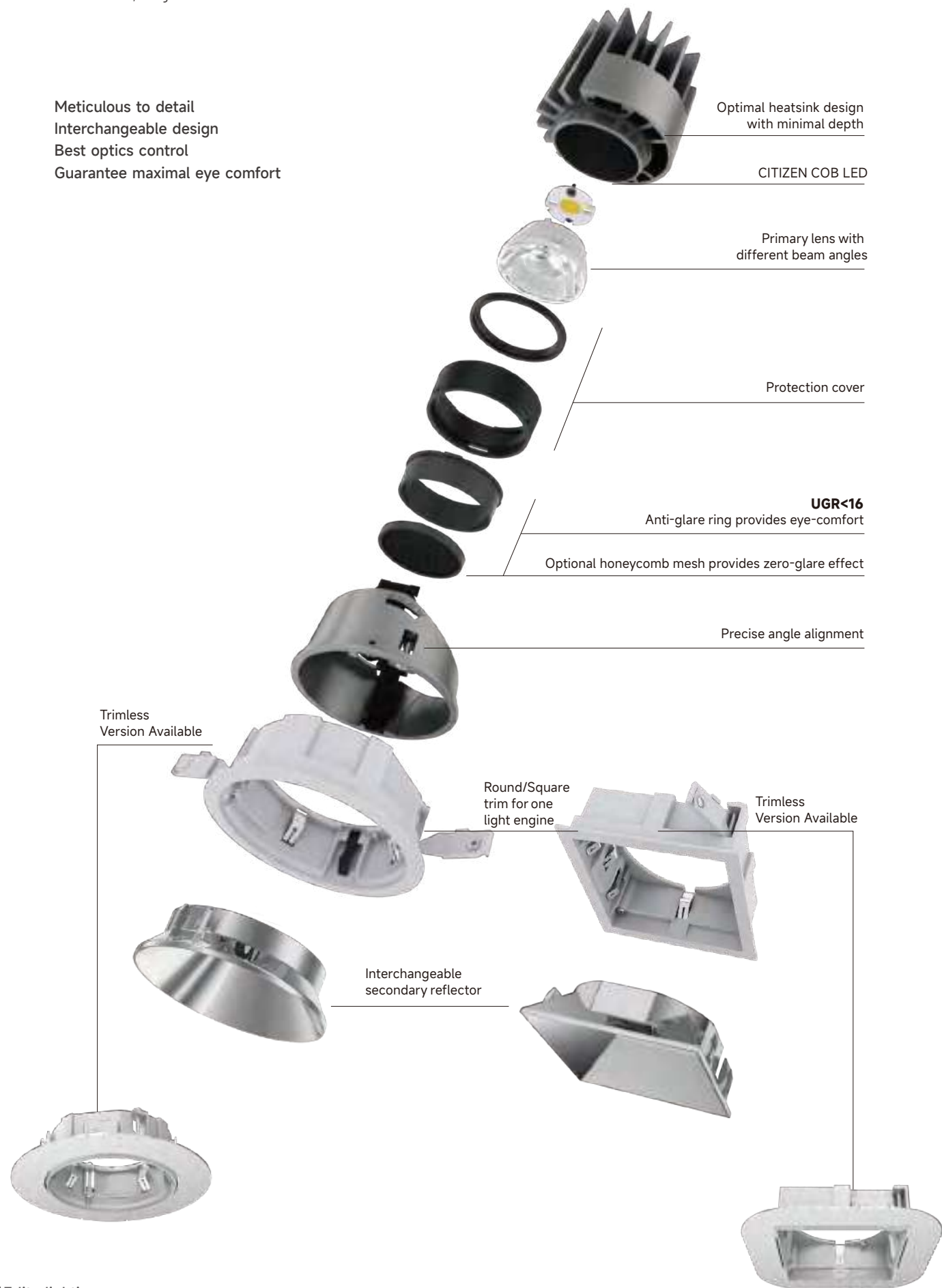

Adjustable

Aesthetic design trim available in round or square shape.
Five sizes with LED wattages 4W-38W.
30° tilt and 355° rotation.
Smart mechanical design ensures precise alignment.

START Series
DOWNLIGHT / Adjustable



Downlight
SRA45/68/100/125/150



Features

- One light engine with various accessories.
- Easy to specify, easy to manage stock.
- Easy to install and adjust
- Easy to change reflector

Specifications

- Dimming modes: ON-OFF, Phase, 1-10V, Dali
- Beam angle: 20°, 40°, 50°
- Physical: Die-casting, wet painting
- Accessories: Honeycomb louver

Type

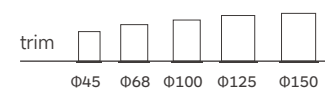

Light distribution

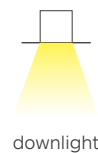

Anti-glare Accessory



Secondary Reflector



SRA45

Downlight

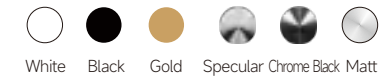

Drawing

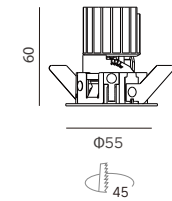

Order Options

4W 350lm-380lm		CREE						
Code	Size	System LM	LED Voltage	LED Current	System W	CRI	CCT	Beam
SRA45-EY930L18M-X	Ø55*60mm	350 lm	12 V	350mA	6 W	90	3000K	18°
SRA45-EY940L18M-X	Ø55*60mm	380 lm	12 V	350mA	6 W	90	4000K	18°
SRA45-EY930L24M-X	Ø55*60mm	350 lm	12 V	350mA	6 W	90	3000K	24°
SRA45-EY940L24M-X	Ø55*60mm	380 lm	12 V	350mA	6 W	90	4000K	24°
SRA45-EY930L35M-X	Ø55*60mm	350 lm	12 V	350mA	6 W	90	3000K	35°
SRA45-EY940L35M-X	Ø55*60mm	380 lm	12 V	350mA	6 W	90	4000K	35°
SRA45-EY930L50M-X	Ø55*60mm	350 lm	12 V	350mA	6 W	90	3000K	50°
SRA45-EY940L50M-X	Ø55*60mm	380 lm	12 V	350mA	6 W	90	4000K	50°

Remark: X=F (ON-OFF) X=P (Phase Dim) X=A (1-10V Dim) X=D (DALI Dim) X=N (Without Driver)

START Series
DOWNLIGHT / Adjustable



SRA68/TRA68
Downlight

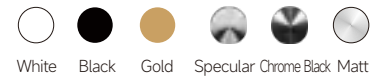

Drawing

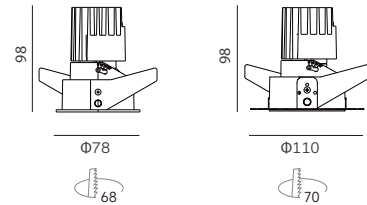

7.5 W 600lm-650lm		CITIZEN							
Code	Size	System LM	LED Voltage	LED W	System W	CRI	CCT	Beam	
SRA68-CA930L20S-X	Ø78*98mm	600 lm	31 V	7.5W	9 W	90	3000K	24°	
SRA68-CA940L20S-X	Ø78*98mm	650 lm	31 V	7.5W	9 W	90	4000K	24°	
SRA68-CA930L40S-X	Ø78*98mm	600 lm	31 V	7.5W	9 W	90	3000K	40°	
SRA68-CA940L40S-X	Ø78*98mm	650 lm	31 V	7.5W	9 W	90	4000K	40°	
SRA68-CA930R55S-X	Ø78*98mm	500 lm	31 V	7.5W	9 W	90	3000K	55°	
SRA68-CA940R55S-X	Ø78*98mm	550 lm	31 V	7.5W	9 W	90	4000K	55°	

Remark: X=F (ON-OFF) X=P (Phase Dim) X=A (1-10V Dim) X=D (DALI Dim) X=N (Without Driver)

11 W 800lm-850lm		CITIZEN							
Code	Size	System LM	LED Voltage	LED W	System W	CRI	CCT	Beam	
SRA68-CB930L20S-X	Ø78*98mm	800 lm	31 V	11 W	13 W	90	3000K	24°	
SRA68-CB940L20S-X	Ø78*98mm	850 lm	31 V	11 W	13 W	90	4000K	24°	
SRA68-CB930L40S-X	Ø78*98mm	800 lm	31 V	11 W	13 W	90	3000K	40°	
SRA68-CB940L40S-X	Ø78*98mm	850 lm	31 V	11 W	13 W	90	4000K	40°	
SRA68-CB930R55S-X	Ø78*98mm	650 lm	31 V	11 W	13 W	90	3000K	55°	
SRA68-CB940R55S-X	Ø78*98mm	700 lm	31 V	11 W	13 W	90	4000K	55°	

Remark: X=F (ON-OFF) X=P (Phase Dim) X=A (1-10V Dim) X=D (DALI Dim) X=N (Without Driver)

8.5 W 480lm-500lm		CREE							
Code	Size	System LM	LED Voltage	LED W	System W	CRI	CCT	Beam	
SRA68-EA930L10S-X	Ø78*98mm	480 lm	12V	8.5 W	10W	90	3000K	10°	
SRA68-EA940L10S-X	Ø78*98mm	500 lm	12V	8.5 W	10W	90	4000K	10°	

Remark: X=F (ON-OFF) X=P (Phase Dim) X=A (1-10V Dim) X=D (DALI Dim) X=N (Without Driver)



SRA100/TRA100
Downlight

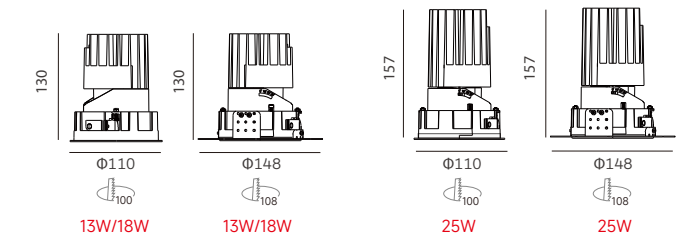
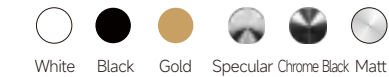

13W 1100Lm-1300Lm		CITIZEN							
Code	Size	System LM	LED Voltage	LED W	System W	CRI	CCT	Beam	
SRA100-CB930L20S-X	Ø110*130mm	1100 lm	36 V	13 W	15 W	90	3000K	20°	
SRA100-CB940L20S-X	Ø110*130mm	1200 lm	36 V	13 W	15 W	90	4000K	20°	
SRA100-CB930L30S-X	Ø110*130mm	1200 lm	36 V	13 W	15 W	90	3000K	30°	
SRA100-CB940L30S-X	Ø110*130mm	1300 lm	36 V	13 W	15 W	90	4000K	30°	
SRA100-CB930L40S-X	Ø110*130mm	1200 lm	36 V	13 W	15 W	90	3000K	40°	
SRA100-CB940L40S-X	Ø110*130mm	1300 lm	36V	13 W	15 W	90	4000K	40°	
SRA100-CB930L45S-X	Ø110*130mm	1100 lm	36 V	13 W	15 W	90	3000K	45°	
SRA100-CB940L45S-X	Ø110*130mm	1200 lm	36 V	13 W	15 W	90	4000K	45°	

Remark: X=F (ON-OFF) X=P (Phase Dim) X=A (1-10V Dim) X=D (DALI Dim) X=N (Without Driver)

18W 1600Lm-1800Lm		CITIZEN							
Code	Size	System LM	LED Voltage	LED W	System W	CRI	CCT	Beam	
SRA100-CC930L20S-X	Ø110*130mm	1600 lm	36 V	18 W	21 W	90	3000K	20°	
SRA100-CC940L20S-X	Ø110*130mm	1700 lm	36 V	18 W	21 W	90	4000K	20°	
SRA100-CC930L30S-X	Ø110*130mm	1700 lm	36 V	18 W	21 W	90	3000K	30°	
SRA100-CC940L30S-X	Ø110*130mm	1800 lm	36 V	18 W	21 W	90	4000K	30°	
SRA100-CC930L40S-X	Ø110*130mm	1700 lm	36 V	18 W	21 W	90	3000K	40°	
SRA100-CC940L40S-X	Ø110*130mm	1800 lm	36 V	18 W	21 W	90	4000K	40°	
SRA100-CC930L45S-X	Ø110*130mm	1600 lm	36 V	18 W	21 W	90	3000K	45°	
SRA100-CC940L45S-X	Ø110*130mm	1700 lm	36 V	18 W	21 W	90	4000K	45°	

Remark: X=F (ON-OFF) X=P (Phase Dim) X=A (1-10V Dim) X=D (DALI Dim) X=N (Without Driver)

7W 500Lm-550Lm		CREE							
Code	Size	System LM	LED Voltage	LED W	System W	CRI	CCT	Beam	
SRA100-CA930L10S-X	Ø110*130mm	500 lm	36 V	7 W	9 W	90	3000K	10°	
SRA100-CA940L10S-X	Ø110*130mm	550 lm	36 V	7 W	9 W	90	4000K	10°	

25W 2100Lm-2300Lm		CITIZEN							
Code	Size	System LM	LED Voltage	LED W	System W	CRI	CCT	Beam	
SRA100-CD930L20S-X	Ø110*157mm	2100 lm	36V	25W	28W	90	3000K	20°	
SRA100-CD940L20S-X	Ø110*157mm	2200 lm	36V	25W	28W	90	4000K	20°	
SRA100-CD930L36S-X	Ø110*157mm	2200 lm	36V	25W	28W	90	3000K	36°	
SRA100-CD940L36S-X	Ø110*157mm	2300 lm	36V	25W	28W	90	4000K	36°	
SRA100-CD930L50S-X	Ø110*157mm	2200 lm	36V	25W	28W	90	3000K	50°	
SRA100-CD940L50S-X	Ø110*157mm	2300 lm	36V	25W	28W	90	4000K	50°	

Remark: X=F (ON-OFF) X=P (Phase Dim) X=A (1-10V Dim) X=D (DALI Dim) X=N (Without Driver)

START Series
DOWNLIGHT / Adjustable



SRA125/TRA125
Downlight

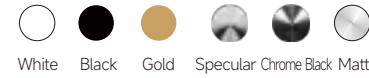

Drawing

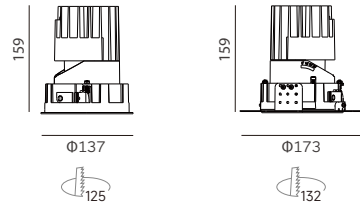

Order Options

18W 1400Lm-1700Lm		CITIZEN						
Code	Size	System LM	LED Voltage	LED W	System W	CRI	CCT	Beam
SRA125-CC930L20S-X	Φ137*159mm	1600 lm	36 V	18 W	21 W	90	3000K	20°
SRA125-CC940L20S-X	Φ137*159mm	1700 lm	36 V	18 W	21 W	90	4000K	20°
SRA125-CC930L35S-X	Φ137*159mm	1600 lm	36 V	18 W	21 W	90	3000K	35°
SRA125-CC940L35S-X	Φ137*159mm	1700 lm	36 V	18 W	21 W	90	4000K	35°
SRA125-CC930L50S-X	Φ137*159mm	1400 lm	36 V	18 W	21 W	90	3000K	50°
SRA125-CC940L50S-X	Φ137*159mm	1500 lm	36 V	18 W	21 W	90	4000K	50°

Remark: X=F (ON-OFF) X=P (Phase Dim) X=A (1-10V Dim) X=D (DALI Dim) X=N (Without Driver)

25W 1900Lm-2300Lm		CITIZEN						
Code	Size	System LM	LED Voltage	LED W	System W	CRI	CCT	Beam
SRA125-CD930L20S-X	Φ137*159mm	2200 lm	36 V	25 W	28 W	90	3000K	20°
SRA125-CD940L20S-X	Φ137*159mm	2300 lm	36 V	25 W	28 W	90	4000K	20°
SRA125-CD930L35S-X	Φ137*159mm	2200 lm	36 V	25 W	28 W	90	3000K	35°
SRA125-CD940L35S-X	Φ137*159mm	2300 lm	36 V	25 W	28 W	90	4000K	35°
SRA125-CD930L50S-X	Φ137*159mm	1900 lm	36 V	25 W	28 W	90	3000K	50°
SRA125-CD940L50S-X	Φ137*159mm	2000 lm	36 V	25 W	28 W	90	4000K	50°

Remark: X=F (ON-OFF) X=P (Phase Dim) X=A (1-10V Dim) X=D (DALI Dim) X=N (Without Driver)



SRA150/TRA150
Downlight

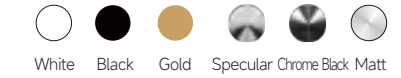

Drawing

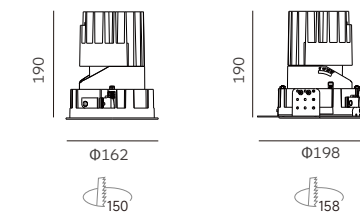

Order Options

25W 1700Lm-2500Lm		CITIZEN						
Code	Size	System LM	LED Voltage	LED W	System W	CRI	CCT	Beam
SRA150-CD930L20S-X	162*190mm	2400 lm	36 V	25 W	28 W	90	3000K	20°
SRA150-CD940L20S-X	162*190mm	2500 lm	36 V	25 W	28 W	90	4000K	20°
SRA150-CD930L35S-X	162*190mm	2400 lm	36 V	25 W	28 W	90	3000K	35°
SRA150-CD940L35S-X	162*190mm	2500 lm	36 V	25 W	28 W	90	4000K	35°
SRA150-CD930L50S-X	162*190mm	1700 lm	36 V	25 W	28 W	90	3000K	50°
SRA150-CD940L50S-X	162*190mm	1800 lm	36 V	25 W	28 W	90	4000K	50°

Remark: X=F (ON-OFF) X=P (Phase Dim) X=A (1-10V Dim) X=D (DALI Dim) X=N (Without Driver)

38W 2600Lm-3300Lm		CITIZEN						
Code	Size	System LM	LED Voltage	LED W	System W	CRI	CCT	Beam
SRA150-CF930L20S-X	162*190mm	3200 lm	36 V	38 W	42 W	90	3000K	20°
SRA150-CF940L20S-X	162*190mm	3300 lm	36 V	38 W	42 W	90	4000K	20°
SRA150-CF930L35S-X	162*190mm	3200 lm	36 V	38 W	42 W	90	3000K	35°
SRA150-CF940L35S-X	162*190mm	3300 lm	36 V	38 W	42 W	90	4000K	35°
SRA150-CF930L50S-X	162*190mm	2600 lm	36 V	38 W	42 W	90	3000K	50°
SRA150-CF940L50S-X	162*190mm	2700 lm	36 V	38 W	42 W	90	4000K	50°

Remark: X=F (ON-OFF) X=P (Phase Dim) X=A (1-10V Dim) X=D (DALI Dim) X=N (Without Driver)

START Series
DOWNLIGHT / Adjustable



SSA45
Downlight

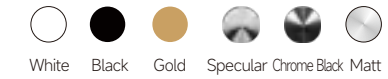

Drawing

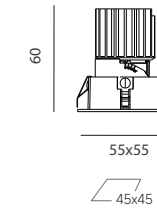

Order Options

4 W 350lm-380lm		CREE							
Code	Size	System LM	LED Voltage	LED Current	System W	CRI	CCT	Beam	
SSA45-EY930L18M-X	55*60mm	350 lm	12 V	350mA	6 W	90	3000K	18°	
SSA45-EY940L18M-X	55*60mm	380 lm	12 V	350mA	6 W	90	4000K	18°	
SSA45-EY930L24M-X	55*60mm	350 lm	12 V	350mA	6 W	90	3000K	24°	
SSA45-EY940L24M-X	55*60mm	380 lm	12 V	350mA	6 W	90	4000K	24°	
SSA45-EY930L35M-X	55*60mm	350 lm	12 V	350mA	6 W	90	3000K	35°	
SSA45-EY940L35M-X	55*60mm	380 lm	12 V	350mA	6 W	90	4000K	35°	
SSA45-EY930L50M-X	55*60mm	350 lm	12 V	350mA	6 W	90	3000K	50°	
SSA45-EY940L50M-X	55*60mm	380 lm	12 V	350mA	6 W	90	4000K	50°	

Remark: X=F (ON-OFF) X=P (Phase Dim) X=A (1-10V Dim) X=D (DALI Dim) X=N (Without Driver)

Downlight
SSA45/68/100/125/150



Features

- One light engine with various accessories.
- Easy to specify, easy to manage stock.
- Easy to install and adjust
- Easy to change reflector

Specifications

- Dimming modes: ON-OFF, Phase, 1-10V, Dali
- Beam angle: 20°, 40°, 50°
- Physical: Die-casting, wet painting
- Accessories: Honeycomb louver

Type

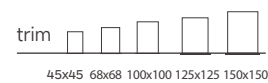

Light distribution

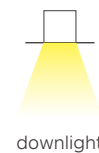

Anti-glare Accessory



Secondary Reflector



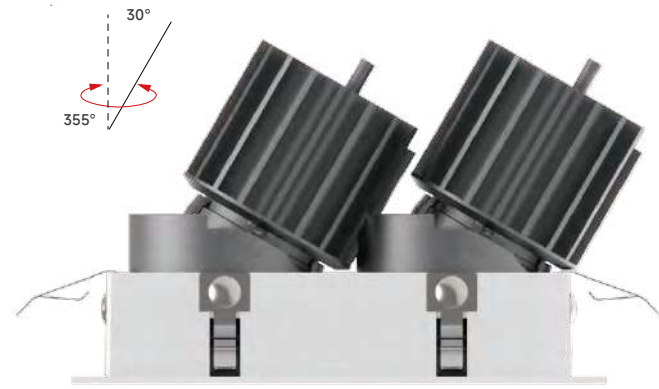

Secondary Reflector



White

Matt

Black

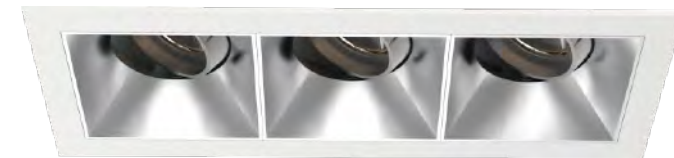

Twin SSA45

Trip SSA45

Quadri SSA45



86*45

126*45

86*86

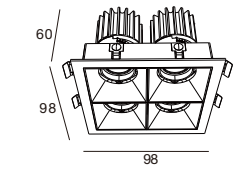
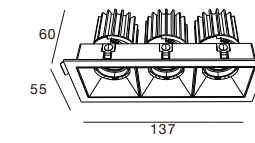
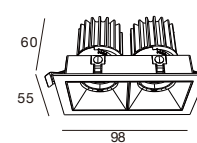

START Series
DOWNLIGHT / Adjustable



SSA68/TSA68
Downlight

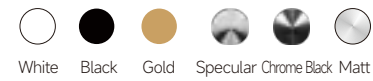

Drawing

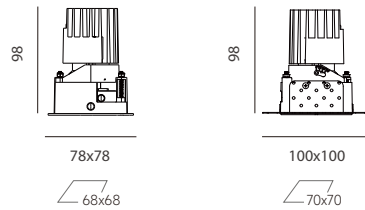

Order Options

7.5 W 600lm-650lm CITIZEN

Code	Size	System LM	LED Voltage	LED W	System W	CRI	CCT	Beam
SSA68-CA930L20S-X	78*98mm	600 lm	31 V	7.5 W	9 W	90	3000K	24°
SSA68-CA940L20S-X	78*98mm	650 lm	31 V	7.5 W	9 W	90	4000K	24°
SSA68-CA930L40S-X	78*98mm	600 lm	31 V	7.5 W	9 W	90	3000K	40°
SSA68-CA940L40S-X	78*98mm	650 lm	31 V	7.5 W	9 W	90	4000K	40°
SSA68-CA930R55S-X	78*98mm	500 lm	31 V	7.5 W	9 W	90	3000K	55°
SSA68-CA940R55S-X	78*98mm	550 lm	31 V	7.5 W	9 W	90	4000K	55°

Remark: X=F (ON-OFF) X=P (Phase Dim) X=A (1-10V Dim) X=D (DALI Dim) X=N (Without Driver)

11 W 800lm-850lm CITIZEN

Code	Size	System LM	LED Voltage	LED W	System W	CRI	CCT	Beam
SSA68-CB930L20S-X	78*98mm	800 lm	31 V	11 W	13 W	90	3000K	24°
SSA68-CB940L20S-X	78*98mm	850 lm	31 V	11 W	13 W	90	4000K	24°
SSA68-CB930L40S-X	78*98mm	800 lm	31 V	11 W	13 W	90	3000K	40°
SSA68-CB940L40S-X	78*98mm	850 lm	31 V	11 W	13 W	90	4000K	40°
SSA68-CB930R55S-X	78*98mm	650 lm	31 V	11 W	13 W	90	3000K	55°
SSA68-CB940R55S-X	78*98mm	700 lm	31 V	11 W	13 W	90	4000K	55°

Remark: X=F (ON-OFF) X=P (Phase Dim) X=A (1-10V Dim) X=D (DALI Dim) X=N (Without Driver)

8.5 W 480lm-500lm CITIZEN

Code	Size	System LM	LED Voltage	LED Current	System W	CRI	CCT	Beam
SSA68-EA930L10S-X	78*98mm	480 lm	12 V	700mA	10 W	90	3000K	10°
SSA68-EA940L10S-X	78*98mm	500 lm	12 V	700mA	10 W	90	4000K	10°



SSA100/TSA100
Downlight

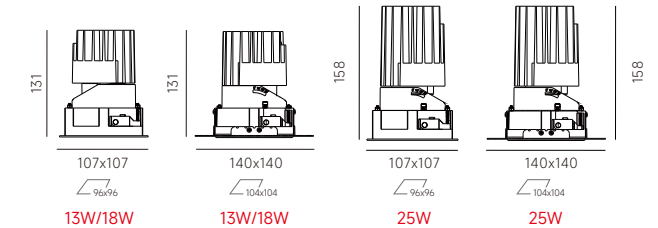
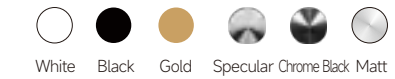

13W 1100Lm-1300Lm CITIZEN

Code	Size	System LM	LED Voltage	LED W	System W	CRI	CCT	Beam
SSA100-CB930L20S-X	Φ107*131mm	1100 lm	36 V	13 W	15 W	90	3000K	20°
SSA100-CB940L20S-X	Φ107*131mm	1200 lm	36 V	13 W	15 W	90	4000K	20°
SSA100-CB930L30S-X	Φ107*131mm	1200 lm	36 V	13 W	15 W	90	3000K	30°
SSA100-CB940L30S-X	Φ107*131mm	1300 lm	36 V	13 W	15 W	90	4000K	30°
SSA100-CB930L40S-X	Φ107*131mm	1200 lm	36 V	13 W	15 W	90	3000K	40°
SSA100-CB940L40S-X	Φ107*131mm	1300 lm	36V	13 W	15 W	90	4000K	40°
SSA100-CB930L45S-X	Φ107*131mm	1100 lm	36 V	13 W	15 W	90	3000K	45°
SSA100-CB940L45S-X	Φ107*131mm	1200 lm	36 V	13 W	15 W	90	4000K	45°

Remark: X=F (ON-OFF) X=P (Phase Dim) X=A (1-10V Dim) X=D (DALI Dim) X=N (Without Driver)

18W 1600Lm-1800Lm CITIZEN

Code	Size	System LM	LED Voltage	LED W	System W	CRI	CCT	Beam
SSA100-CC930L20S-X	Φ107*131mm	1600 lm	36 V	18 W	21 W	90	3000K	20°
SSA100-CC940L20S-X	Φ107*131mm	1700 lm	36 V	18 W	21 W	90	4000K	20°
SSA100-CC930L30S-X	Φ107*131mm	1700 lm	36 V	18 W	21 W	90	3000K	30°
SSA100-CC940L30S-X	Φ107*131mm	1800 lm	36 V	18 W	21 W	90	4000K	30°
SSA100-CC930L40S-X	Φ107*131mm	1700 lm	36 V	18 W	21 W	90	3000K	40°
SSA100-CC940L40S-X	Φ107*131mm	1800 lm	36 V	18 W	21 W	90	4000K	40°
SSA100-CC930L45S-X	Φ107*131mm	1600 lm	36 V	18 W	21 W	90	3000K	45°
SSA100-CC940L45S-X	Φ107*131mm	1700 lm	36 V	18 W	21 W	90	4000K	45°

Remark: X=F (ON-OFF) X=P (Phase Dim) X=A (1-10V Dim) X=D (DALI Dim) X=N (Without Driver)

7W 500Lm-550Lm CREE

Code	Size	System LM	LED Voltage	LED W	System W	CRI	CCT	Beam
SSA100-CA930L10S-X	Φ107*131mm	500 lm	36 V	7 W	9 W	90	3000K	10°
SSA100-CA940L10S-X	Φ107*131mm	550 lm	36 V	7 W	9 W	90	4000K	10°

25W 2100Lm-2300Lm CITIZEN

Code	Size	System LM	LED Voltage	LED W	System W	CRI	CCT	Beam
SSA100-CD930L20S-X	Φ107*158mm	2100 lm	36V	25W	28W	90	3000K	20°
SSA100-CD940L20S-X	Φ107*158mm	2200 lm	36V	25W	28W	90	4000K	20°
SSA100-CD930L36S-X	Φ107*158mm	2200 lm	36V	25W	28W	90	3000K	36°
SSA100-CD940L36S-X	Φ107*158mm	2300 lm	36V	25W	28W	90	4000K	36°
SSA100-CD930L50S-X	Φ107*158mm	2200 lm	36V	25W	28W	90	3000K	50°
SSA100-CD940L50S-X	Φ107*158mm	2300 lm	36V	25W	28W	90	4000K	50°

Remark: X=F (ON-OFF) X=P (Phase Dim) X=A (1-10V Dim) X=D (DALI Dim) X=N (Without Driver)



Secondary Reflector



Twin SSA68 \triangleleft 134*68



Trip SSA68 \triangleleft 198*68



Quadri SSA68 \triangleleft 134*134

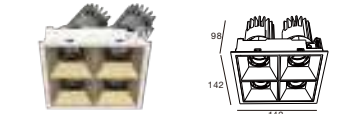

Twin TSA68 \triangleleft 136*70



Trip TSA6 \triangleleft 200*70



Quadri TSA68 \triangleleft 136*136

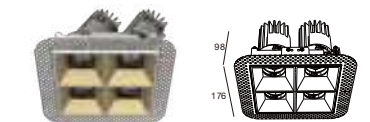

START Series
DOWNLIGHT / Adjustable



SSA125/TSA125
Downlight

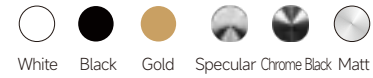

Drawing

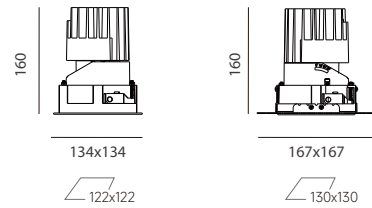

Order Options

18W 1400Lm-1700Lm		CITIZEN						
Code	Size	System LM	LED Voltage	LED W	System W	CRI	CCT	Beam
SSA125-CC930L20S-X	134*160mm	1600 lm	36 V	18 W	21 W	90	3000K	20°
SSA125-CC940L20S-X	134*160mm	1700 lm	36 V	18 W	21 W	90	4000K	20°
SSA125-CC930L35S-X	134*160mm	1600 lm	36 V	18 W	21 W	90	3000K	35°
SSA125-CC940L35S-X	134*160mm	1700 lm	36 V	18 W	21 W	90	4000K	35°
SSA125-CC930L50S-X	134*160mm	1400 lm	36 V	18 W	21 W	90	3000K	50°
SSA125-CC940L50S-X	134*160mm	1500 lm	36 V	18 W	21 W	90	4000K	50°

Remark: X=F (ON-OFF) X=P (Phase Dim) X=A (1-10V Dim) X=D (DALI Dim) X=N (Without Driver)

25W 1900Lm-2300Lm		CITIZEN						
Code	Size	System LM	LED Voltage	LED W	System W	CRI	CCT	Beam
SSA125-CD930L20S-X	134*160mm	2200 lm	36 V	25 W	28 W	90	3000K	20°
SSA125-CD940L20S-X	134*160mm	2300 lm	36 V	25 W	28 W	90	4000K	20°
SSA125-CD930L35S-X	134*160mm	2200 lm	36 V	25 W	28 W	90	3000K	35°
SSA125-CD940L35S-X	134*160mm	2300 lm	36 V	25 W	28 W	90	4000K	35°
SSA125-CD930L50S-X	134*160mm	1900 lm	36 V	25 W	28 W	90	3000K	50°
SSA125-CD940L50S-X	134*160mm	2000 lm	36 V	25 W	28 W	90	4000K	50°

Remark: X=F (ON-OFF) X=P (Phase Dim) X=A (1-10V Dim) X=D (DALI Dim) X=N (Without Driver)



START Series
DOWNLIGHT / Adjustable



SSA150/TSA150
Downlight

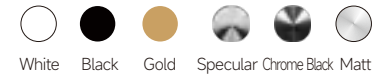

Drawing

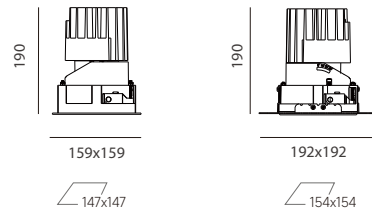

Order Options

25W 1700Lm-2500Lm CITIZEN

Code	Size	System LM	LED Voltage	LED W	System W	CRI	CCT	Beam
SSA150-CD930L20S-X	162*190mm	2400 lm	36 V	25 W	28 W	90	3000K	20°
SSA150-CD940L20S-X	162*190mm	2500 lm	36 V	25 W	28 W	90	4000K	20°
SSA150-CD930L35S-X	162*190mm	2400 lm	36 V	25 W	28 W	90	3000K	35°
SSA150-CD940L35S-X	162*190mm	2500 lm	36 V	25 W	28 W	90	4000K	35°
SSA150-CD930L50S-X	162*190mm	1700 lm	36 V	25 W	28 W	90	3000K	50°
SSA150-CD940L50S-X	162*190mm	1800 lm	36 V	25 W	28 W	90	4000K	50°

Remark: X=F (ON-OFF) X=P (Phase Dim) X=A (1-10V Dim) X=D (DALI Dim) X=N (Without Driver)

38W 2600Lm-3300Lm CITIZEN

Code	Size	System LM	LED Voltage	LED W	System W	CRI	CCT	Beam
SSA150-CF930L20S-X	162*190mm	3200 lm	36 V	38 W	42 W	90	3000K	20°
SSA150-CF940L20S-X	162*190mm	3300 lm	36 V	38 W	42 W	90	4000K	20°
SSA150-CF930L35S-X	162*190mm	3200 lm	36 V	38 W	42 W	90	3000K	35°
SSA150-CF940L35S-X	162*190mm	3300 lm	36 V	38 W	42 W	90	4000K	35°
SSA150-CF930L50S-X	162*190mm	2600 lm	36 V	38 W	42 W	90	3000K	50°
SSA150-CF940L50S-X	162*190mm	2700 lm	36 V	38 W	42 W	90	4000K	50°

Remark: X=F (ON-OFF) X=P (Phase Dim) X=A (1-10V Dim) X=D (DALI Dim) X=N (Without Driver)



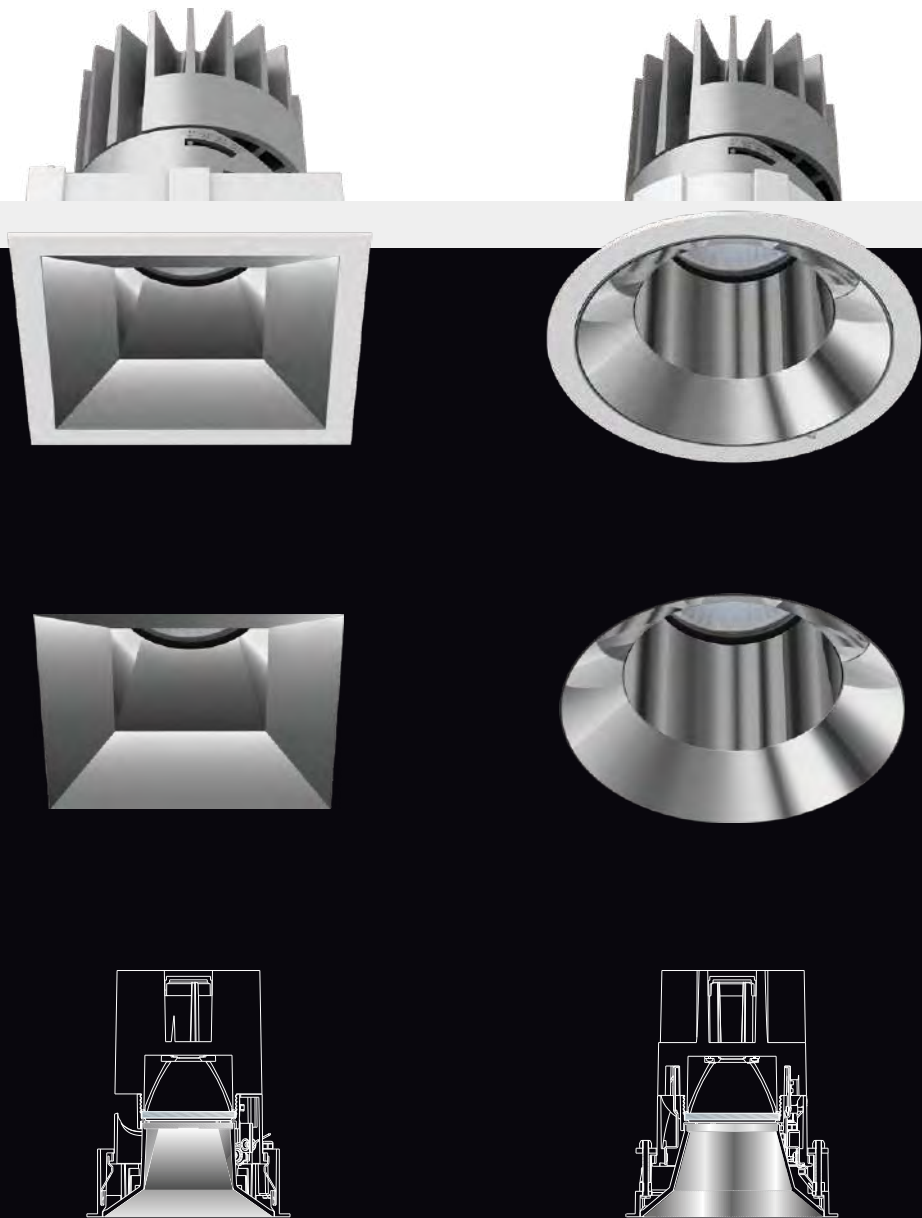

Fixed

Aesthetic design trim available in round or square shape.
Three sizes with LED wattages 13W-38W.
Deep recessed secondary reflector generates visual comfort

Fixed

Meticulous to detail
Interchangeable design
Best optics control
Guarantee maximal eye comfort



FIXED

SRF100	TRF100	SRF125	TRF125	SRF150	TRF150
SSF100	TSF100	SSF125	TSF125	SSF150	TSF150

START Series
DOWNLIGHT / FIXED



Downlight
SRF100/125/150



Features

- One light engine with various accessories.
- Easy to specify, easy to manage stock.
- Easy to install and adjust
- Easy to change reflector

Specifications

- Dimming modes: ON-OFF, Phase, 1-10V, Dali
- Beam angle: 20°, 40°, 50°
- Physical: Die-casting, wet painting
- Accessories: Honeycomb louver

Type

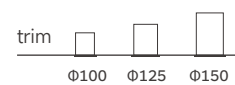

Light distribution



downlight

TRIM



TRIMLESS



Secondary Reflector



Specular Chrome Black White Matt Black Gold



SRF100/TRF100
Downlight

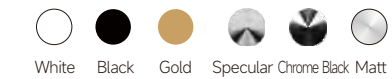

Drawing

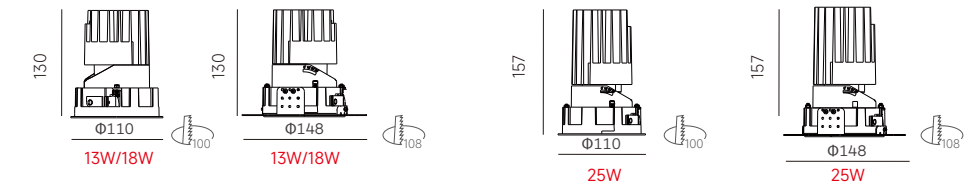

13W 1050Lm-1200Lm

CITIZEN

Code	Size	System LM	LED Voltage	LED W	System W	CRI	CCT	Beam
SRF100-CB930L25S-X	Ø110*130mm	1050 lm	36 V	13 W	15 W	90	3000K	25°
SRF100-CB940L25S-X	Ø110*130mm	1100 lm	36 V	13 W	15 W	90	4000K	25°
SRF100-CB930L30S-X	Ø110*130mm	1100 lm	36 V	13 W	15 W	90	3000K	30°
SRF100-CB940L30S-X	Ø110*130mm	1200 lm	36 V	13 W	15 W	90	4000K	30°
SRF100-CB930L40S-X	Ø110*130mm	1100 lm	36 V	13 W	15 W	90	3000K	40°
SRF100-CB940L40S-X	Ø110*130mm	1200 lm	36V	13 W	15 W	90	4000K	40°
SRF100-CB930L45S-X	Ø110*130mm	1050 lm	36 V	13 W	15 W	90	3000K	45°
SRF100-CB940L45S-X	Ø110*130mm	1100 lm	36 V	13 W	15 W	90	4000K	45°

Remark: X=F (ON-OFF) X=P (Phase Dim) X=A (1-10V Dim) X=D (DALI Dim) X=N (Without Driver)

18W 1500Lm-1600Lm

CITIZEN

Code	Size	System LM	LED Voltage	LED W	System W	CRI	CCT	Beam
SRF100-CC930L20S-X	Ø110*130mm	1400 lm	36 V	18 W	21 W	90	3000K	20°
SRF100-CC940L20S-X	Ø110*130mm	1500 lm	36 V	18 W	21 W	90	4000K	20°
SRF100-CC930L30S-X	Ø110*130mm	1500 lm	36 V	18 W	21 W	90	3000K	30°
SRF100-CC940L30S-X	Ø110*130mm	1600 lm	36 V	18 W	21 W	90	4000K	30°
SRF100-CC930L40S-X	Ø110*130mm	1500 lm	36 V	18 W	21 W	90	3000K	40°
SRF100-CC940L40S-X	Ø110*130mm	1600 lm	36 V	18 W	21 W	90	4000K	40°
SRF100-CC930L45S-X	Ø110*130mm	1500 lm	36 V	18 W	21 W	90	3000K	45°
SRF100-CC940L45S-X	Ø110*130mm	1600 lm	36 V	18 W	21 W	90	4000K	45°

Remark: X=F (ON-OFF) X=P (Phase Dim) X=A (1-10V Dim) X=D (DALI Dim) X=N (Without Driver)

25W 1800Lm-2000Lm

CITIZEN

Code	Size	System LM	LED Voltage	LED W	System W	CRI	CCT	Beam
SRF100-CD930L20S-X	Ø110*157mm	1800 lm	36V	25W	28W	90	3000K	20°
SRF100-CD940L20S-X	Ø110*157mm	1900 lm	36V	25W	28W	90	4000K	20°
SRF100-CD930L36S-X	Ø110*157mm	1900 lm	36V	25W	28W	90	3000K	36°
SRF100-CD940L36S-X	Ø110*157mm	2000 lm	36V	25W	28W	90	4000K	36°
SRF100-CD930L50S-X	Ø110*157mm	1800 lm	36V	25W	28W	90	3000K	50°
SRF100-CD940L50S-X	Ø110*157mm	1900 lm	36V	25W	28W	90	4000K	50°

Remark: X=F (ON-OFF) X=P (Phase Dim) X=A (1-10V Dim) X=D (DALI Dim) X=N (Without Driver)



SRF125/TRF125 Downlight

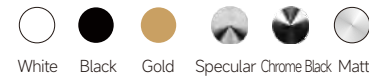

Drawing

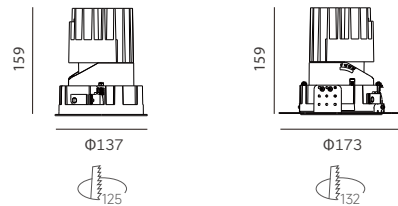

Order Options

18 W 1300lm-1600m		CITIZEN						
Code	Size	System LM	LED Voltage	LED W	System W	CRI	CCT	Beam
SRF125-CC930L28S-X	Φ137*159mm	1500 lm	36 V	18 W	21W	90	3000K	28°
SRF125-CC940L28S-X	Φ137*159mm	1600 lm	36 V	18 W	21W	90	4000K	28°
SRF125-CC930L35S-X	Φ137*159mm	1500 lm	36 V	18 W	21W	90	3000K	35°
SRF125-CC940L35S-X	Φ137*159mm	1600 lm	36 V	18 W	21W	90	4000K	35°
SRF125-CC930L45S-X	Φ137*159mm	1300 lm	36 V	18 W	21W	90	3000K	45°
SRF125-CC940L45S-X	Φ137*159mm	1400 lm	36 V	18 W	21W	90	4000K	45°

Remark: X=F (ON-OFF) X=P (Phase Dim) X=A (1-10V Dim) X=D (DALI Dim) X=N (Without Driver)

25 W 1800lm-2200lm		CITIZEN						
Code	Size	System LM	LED Voltage	LED W	System W	CRI	CCT	Beam
SRF125-CD930L28S-X	Φ137*159mm	2100 lm	36 V	25W	28W	90	3000K	28°
SRF125-CD940L28S-X	Φ137*159mm	2200 lm	36 V	25W	28W	90	4000K	28°
SRF125-CD930L35S-X	Φ137*159mm	2100 lm	36 V	25W	28W	90	3000K	35°
SRF125-CD940L35S-X	Φ137*159mm	2200 lm	36 V	25W	28W	90	4000K	35°
SRF125-CD930L45S-X	Φ137*159mm	1800 lm	36 V	25W	28W	90	3000K	45°
SRF125-CD940L45S-X	Φ137*159mm	1900 lm	36 V	25W	28W	90	4000K	45°

Remark: X=F (ON-OFF) X=P (Phase Dim) X=A (1-10V Dim) X=D (DALI Dim) X=N (Without Driver)



SRF150/TRF150 Downlight

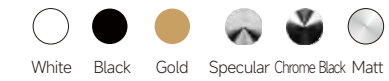

Drawing

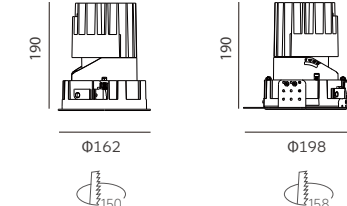

Order Options

25 W 1900lm-2000lm		CITIZEN						
Code	Size	System LM	LED Voltage	LED Current	System W	CRI	CCT	Beam
SRF150-CD930R28S-X	Φ162*190mm	1900 lm	36 V	700mA	28W	90	3000K	28°
SRF150-CD940R28S-X	Φ162*190mm	2000 lm	36 V	700mA	28W	90	4000K	28°
SRF150-CD930R32S-X	Φ162*190mm	1900 lm	36 V	700mA	28W	90	3000K	32°
SRF150-CD940R32S-X	Φ162*190mm	2000 lm	36 V	700mA	28W	90	4000K	32°
SRF150-CD930R50S-X	Φ162*190mm	1900 lm	36 V	700mA	28W	90	3000K	50°
SRF150-CD940R50S-X	Φ162*190mm	2000 lm	36 V	700mA	28W	90	4000K	50°

Remark: X=F (ON-OFF) X=P (Phase Dim) X=A (1-10V Dim) X=D (DALI Dim) X=N (Without Driver)

38 W 2700lm-2900lm		CITIZEN						
Code	Size	System LM	LED Voltage	LED Current	System W	CRI	CCT	Beam
SRF150-CF930R28S-X	Φ78*98mm	2700 lm	36 V	1050mA	42W	90	3000K	28°
SRF150-CF940R28S-X	Φ78*98mm	2900 lm	36 V	1050mA	42W	90	4000K	28°
SRF150-CF930R32S-X	Φ78*98mm	2700 lm	36 V	1050mA	42W	90	3000K	32°
SRF150-CF940R32S-X	Φ78*98mm	2900 lm	36 V	1050mA	42W	90	4000K	32°
SRF150-CF930R50S-X	Φ78*98mm	2700 lm	36 V	1050mA	42W	90	3000K	50°
SRF150-CF940R50S-X	Φ78*98mm	2900 lm	36 V	1050mA	42W	90	4000K	50°

Remark: X=F (ON-OFF) X=P (Phase Dim) X=A (1-10V Dim) X=D (DALI Dim) X=N (Without Driver)

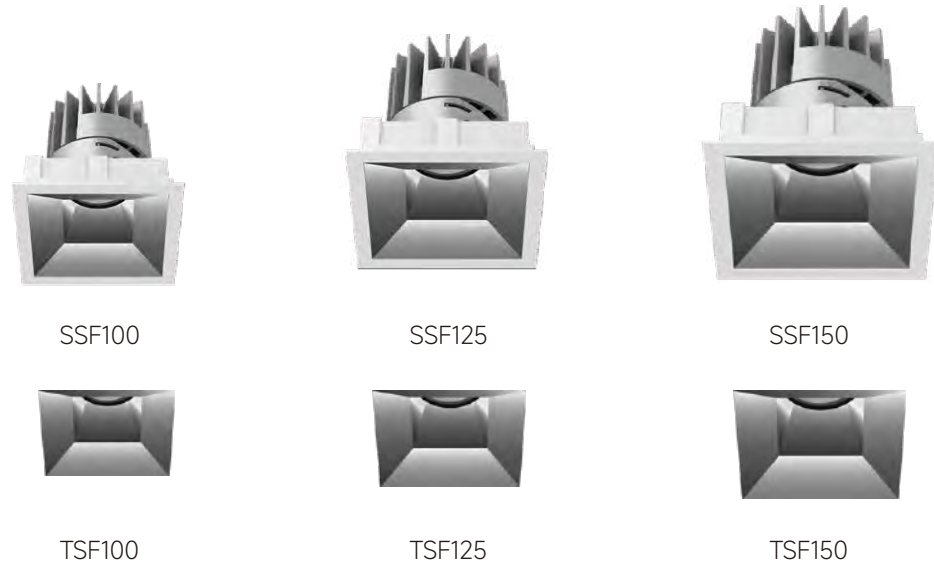

Downlight
SSF100/125/150



Features

- One light engine with various accessories.
- Easy to specify, easy to manage stock.
- Easy to install and adjust
- Easy to change reflector

Specifications

- Dimming modes: ON-OFF, Phase, 1-10V, Dali
- Beam angle: 20°, 40°, 50°
- Physical: Die-casting, wet painting
- Accessories: Honeycomb louver

Type

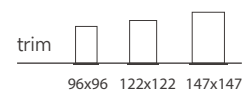

Light distribution

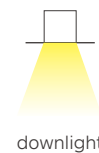

TRIM



TRIMLESS



Secondary Reflector



SSF100/TSF100
Downlight

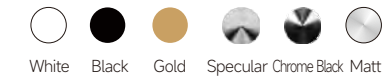

Drawing

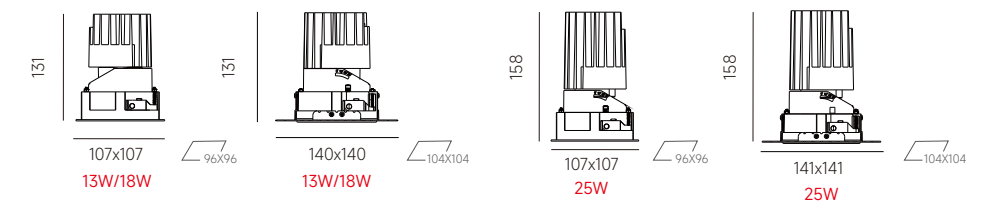

Order Options

13W 1050Lm-1200Lm		CITIZEN						
Code	Size	System LM	LED Voltage	LED W	System W	CRI	CCT	Beam
SSF100-CB930L25S-X	107*131mm	1050 lm	36 V	13 W	15 W	90	3000K	25°
SSF100-CB940L25S-X	107*131mm	1100 lm	36 V	13 W	15 W	90	4000K	25°
SSF100-CB930L30S-X	107*131mm	1100 lm	36 V	13 W	15 W	90	3000K	30°
SSF100-CB940L30S-X	107*131mm	1200 lm	36 V	13 W	15 W	90	4000K	30°
SSF100-CB930L40S-X	107*131mm	1100 lm	36 V	13 W	15 W	90	3000K	40°
SSF100-CB940L40S-X	107*131mm	1200 lm	36V	13 W	15 W	90	4000K	40°
SSF100-CB930L45S-X	107*131mm	1050 lm	36 V	13 W	15 W	90	3000K	45°
SSF100-CB940L45S-X	107*131mm	1100 lm	36 V	13 W	15 W	90	4000K	45°

Remark: X=F (ON-OFF) X=P (Phase Dim) X=A (1-10V Dim) X=D (DALI Dim) X=N (Without Driver)

18W 1500Lm-1600Lm		CITIZEN						
Code	Size	System LM	LED Voltage	LED W	System W	CRI	CCT	Beam
SSF100-CC930L20S-X	107*131mm	1400 lm	36 V	18 W	21 W	90	3000K	20°
SSF100-CC940L20S-X	107*131mm	1500 lm	36 V	18 W	21 W	90	4000K	20°
SSF100-CC930L30S-X	107*131mm	1500 lm	36 V	18 W	21 W	90	3000K	30°
SSF100-CC940L30S-X	107*131mm	1600 lm	36 V	18 W	21 W	90	4000K	30°
SSF100-CC930L40S-X	107*131mm	1500 lm	36 V	18 W	21 W	90	3000K	40°
SSF100-CC940L40S-X	107*131mm	1600 lm	36 V	18 W	21 W	90	4000K	40°
SSF100-CC930L45S-X	107*131mm	1500 lm	36 V	18 W	21 W	90	3000K	45°
SSF100-CC940L45S-X	107*131mm	1600 lm	36 V	18 W	21 W	90	4000K	45°

Remark: X=F (ON-OFF) X=P (Phase Dim) X=A (1-10V Dim) X=D (DALI Dim) X=N (Without Driver)

25W 1800Lm-2000Lm		CITIZEN						
Code	Size	System LM	LED Voltage	LED W	System W	CRI	CCT	Beam
SSF100-CD930L20S-X	107*158mm	1800 lm	36V	25W	28W	90	3000K	20°
SSF100-CD940L20S-X	107*158mm	1900 lm	36V	25W	28W	90	4000K	20°
SSF100-CD930L36S-X	107*158mm	1900 lm	36V	25W	28W	90	3000K	36°
SSF100-CD940L36S-X	107*158mm	2000 lm	36V	25W	28W	90	4000K	36°
SSF100-CD930L50S-X	107*158mm	1800 lm	36V	25W	28W	90	3000K	50°
SSF100-CD940L50S-X	107*158mm	1900 lm	36V	25W	28W	90	4000K	50°

Remark: X=F (ON-OFF) X=P (Phase Dim) X=A (1-10V Dim) X=D (DALI Dim) X=N (Without Driver)



SSF125/TSF125 Downlight

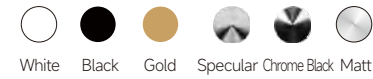

SSF150/TSF150 Downlight

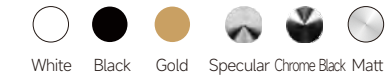

Drawing

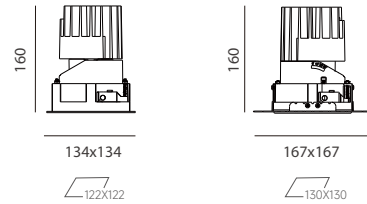

Order Options

18 W 1300lm-1600m		CITIZEN						
Code	Size	System LM	LED Voltage	LED W	System W	CRI	CCT	Beam
SSF125-CC930L28S-X	134*160mm	1500 lm	36 V	18 W	21W	90	3000K	28°
SSF125-CC940L28S-X	134*160mm	1600 lm	36 V	18 W	21W	90	4000K	28°
SSF125-CC930L35S-X	134*160mm	1500 lm	36 V	18 W	21W	90	3000K	35°
SSF125-CC940L35S-X	134*160mm	1600 lm	36 V	18 W	21W	90	4000K	35°
SSF125-CC930L45S-X	134*160mm	1300 lm	36 V	18 W	21W	90	3000K	45°
SSF125-CC940L45S-X	134*160mm	1400 lm	36 V	18 W	21W	90	4000K	45°

Remark: X=F (ON-OFF) X=P (Phase Dim) X=A (1-10V Dim) X=D (DALI Dim) X=N (Without Driver)

25 W 1800lm-2200lm		CITIZEN						
Code	Size	System LM	LED Voltage	LED W	System W	CRI	CCT	Beam
SSF125-CD930L28S-X	134*160mm	2100 lm	36 V	25W	28W	90	3000K	28°
SSF125-CD940L28S-X	134*160mm	2200 lm	36 V	25W	28W	90	4000K	28°
SSF125-CD930L35S-X	134*160mm	2100 lm	36 V	25W	28W	90	3000K	35°
SSF125-CD940L35S-X	134*160mm	2200 lm	36 V	25W	28W	90	4000K	35°
SSF125-CD930L45S-X	134*160mm	1800 lm	36 V	25W	28W	90	3000K	45°
SSF125-CD940L45S-X	134*160mm	1900 lm	36 V	25W	28W	90	4000K	45°

Remark: X=F (ON-OFF) X=P (Phase Dim) X=A (1-10V Dim) X=D (DALI Dim) X=N (Without Driver)

Drawing

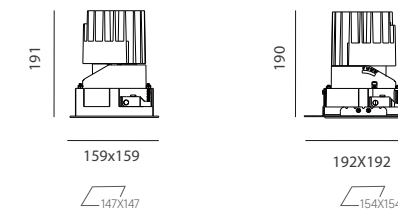

Order Options

25 W 1900lm-2000lm		CITIZEN						
Code	Size	System LM	LED Voltage	LED Current	System W	CRI	CCT	Beam
SSF150-CD930R28S-X	159x191mm	1900 lm	36 V	700mA	28W	90	3000K	28°
SSF150-CD940R28S-X	159x191mm	2000 lm	36 V	700mA	28W	90	4000K	28°
SSF150-CD930R32S-X	159x191mm	1900 lm	36 V	700mA	28W	90	3000K	32°
SSF150-CD940R32S-X	159x191mm	2000 lm	36 V	700mA	28W	90	4000K	32°
SSF150-CD930R50S-X	159x191mm	1900 lm	36 V	700mA	28W	90	3000K	50°
SSF150-CD940R50S-X	159x191mm	2000 lm	36 V	700mA	28W	90	4000K	50°

Remark: X=F (ON-OFF) X=P (Phase Dim) X=A (1-10V Dim) X=D (DALI Dim) X=N (Without Driver)

38 W 2700lm-2900lm		CITIZEN						
Code	Size	System LM	LED Voltage	LED Current	System W	CRI	CCT	Beam
SSF150-CF930R28S-X	159x191mm	2700 lm	36 V	1050mA	42W	90	3000K	28°
SSF150-CF940R28S-X	159x191mm	2900 lm	36 V	1050mA	42W	90	4000K	28°
SSF150-CF930R32S-X	159x191mm	2700 lm	36 V	1050mA	42W	90	3000K	32°
SSF150-CF940R32S-X	159x191mm	2900 lm	36 V	1050mA	42W	90	4000K	32°
SSF150-CF930R50S-X	159x191mm	2700 lm	36 V	1050mA	42W	90	3000K	50°
SSF150-CF940R50S-X	159x191mm	2900 lm	36 V	1050mA	42W	90	4000K	50°

Remark: X=F (ON-OFF) X=P (Phase Dim) X=A (1-10V Dim) X=D (DALI Dim) X=N (Without Driver)



WALL WASHER

Meticulous to detail
Interchangeable design
Best optics control
Guarantee maximal eye comfort

WALL WASHER



START Series
DOWNLIGHT / WALL WASHER



The installation is based on 3M height wall
Evenly illuminated wall without dark shadow at the corner

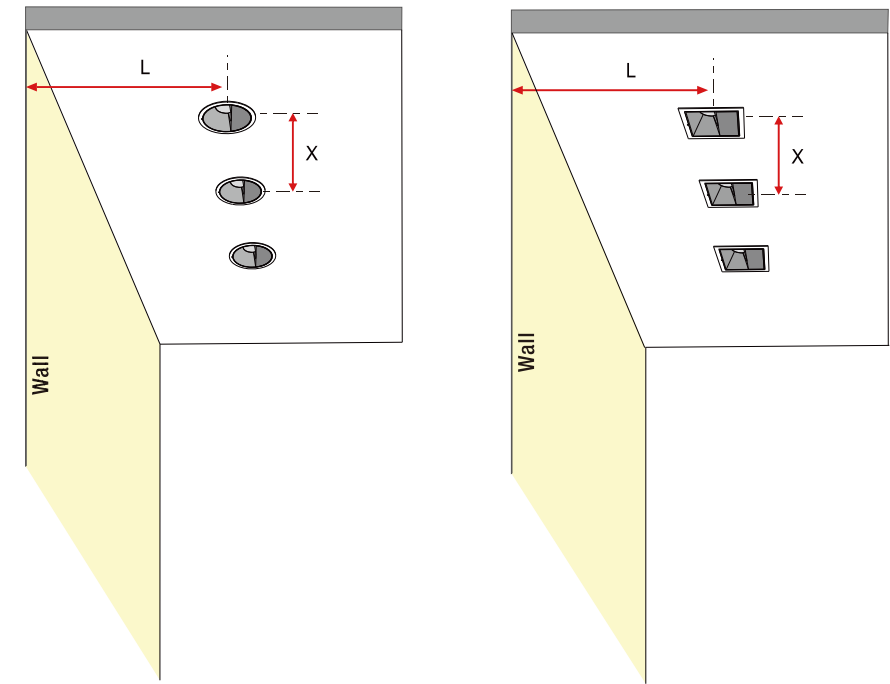

Suggestions on Installation Distance for Uniform Lighting Effects

MODEL	X(mm) L(mm)		500 mm	550 mm	600 mm	650 mm	700 mm	750 mm	800 mm	850 mm	900 mm	950 mm	1000 mm	1050 mm	1100 mm	1150 mm	1200 mm
	SRW100			500 mm	550 mm	600 mm	650 mm	700 mm	750 mm	800 mm	850 mm	900 mm	950 mm	1000 mm	1050 mm	1100 mm	1150 mm
SRW125	X/2	X	500 mm	550 mm	600 mm	650 mm	700 mm	750 mm	800 mm	850 mm	900 mm	950 mm	1000 mm	1050 mm	1100 mm	1150 mm	1200 mm
SRW150			500 mm	550 mm	600 mm	650 mm	700 mm	750 mm	800 mm	850 mm	900 mm	950 mm	1000 mm	1050 mm	1100 mm	1150 mm	1200 mm

MODEL	X(mm) L(mm)		500 mm	550 mm	600 mm	650 mm	700 mm	750 mm	800 mm	850 mm	900 mm	950 mm	1000 mm	1050 mm	1100 mm	1150 mm	1200 mm
	SSW100			550 mm	600 mm	650 mm	700 mm	750 mm	800 mm	850 mm	900 mm	950 mm	1000 mm	1050 mm	1100 mm	1150 mm	1200 mm
SSW125	X/2	X	550 mm	600 mm	650 mm	700 mm	750 mm	800 mm	850 mm	900 mm	950 mm	1000 mm	1050 mm	1100 mm	1150 mm	1200 mm	1250 mm
SSW150			550 mm	600 mm	650 mm	700 mm	750 mm	800 mm	850 mm	900 mm	950 mm	1000 mm	1050 mm	1100 mm	1150 mm	1200 mm	1250 mm

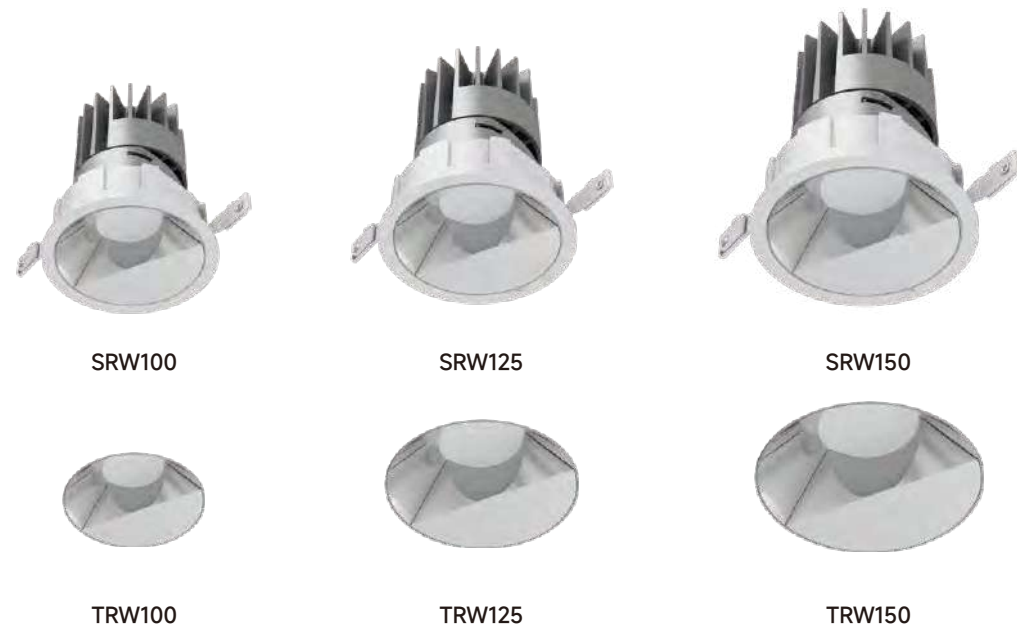

Downlight
SRW100/125/150



Features

- One light engine with various accessories.
- Easy to specify, easy to manage stock.
- Easy to install and adjust
- Easy to change reflector

Specifications

- Dimming modes: ON-OFF, Phase, 1-10V, Dali
- Beam angle: 20°, 40°, 50°
- Physical: Die-casting, wet painting
- Accessories: Honeycomb louver

Type

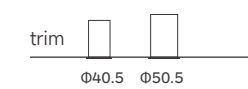

Light distribution

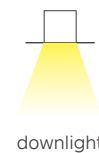

TRIM



TRIMLESS



SRW100/TRW100

Downlight / Wall Washer

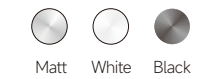

Drawing

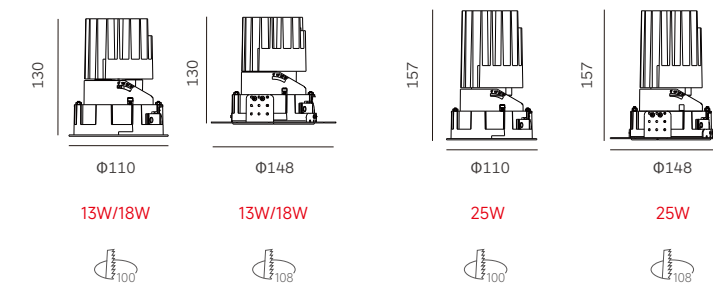

Order Options

13W 600lm-650lm		CITIZEN					
Code	Size	System LM	LED Voltage	LED W	System W	CRI	CCT
SRW100-CB930LW1M-X	Ø110*130mm	600 lm	36 V	13W	15W	90	3000K
SRW100-CB940LW1M-X	Ø110*130mm	650 lm	36 V	13W	15W	90	4000K

Remark: X=F (ON-OFF) X=P (Phase Dim) X=A (1-10V Dim) X=D (DALI Dim) X=N (Without Driver)

18W 800lm-850lm		CITIZEN					
Code	Size	System LM	LED Voltage	LED W	System W	CRI	CCT
SRW100-CC930LW1M-X	Ø110*130mm	800 lm	36 V	18W	21W	90	3000K
SRW100-CC940LW1M-X	Ø110*130mm	850 lm	36 V	18W	21W	90	4000K

Remark: X=F (ON-OFF) X=P (Phase Dim) X=A (1-10V Dim) X=D (DALI Dim) X=N (Without Driver)

25W 1000lm-1100lm		CITIZEN					
Code	Size	System LM	LED Voltage	LED W	System W	CRI	CCT
SRW100-CD930LW1M-X	Ø110*157mm	1000 lm	36 V	25W	28W	90	3000K
SRW100-CD940LW1M-X	Ø110*157mm	1100 lm	36 V	25W	28W	90	4000K

Remark: X=F (ON-OFF) X=P (Phase Dim) X=A (1-10V Dim) X=D (DALI Dim) X=N (Without Driver)



SRW125/TRW125

Downlight / Wall Washer



Drawing

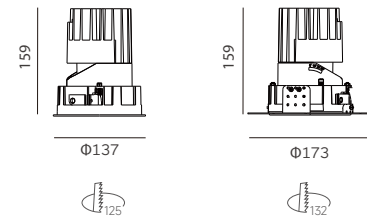

Order Options

18W 800lm-900lm		CITIZEN					
Code	Size	System LM	LED Voltage	LED W	System W	CRI	CCT
SRW125-CC930LW1M-X	Φ137*159mm	800 lm	36 V	18W	21W	90	3000K
SRW125-CC940LW1M-X	Φ137*159mm	900 lm	36 V	18W	21W	90	4000K

Remark: X=F (ON-OFF) X=P (Phase Dim) X=A (1-10V Dim) X=D (DALI Dim) X=N (Without Driver)

25W 1100lm-1200lm		CITIZEN					
Code	Size	System LM	LED Voltage	LED W	System W	CRI	CCT
SRW125-CD930LW1M-X	Φ137*159mm	1100 lm	36 V	25W	28W	90	3000K
SRW125-CD940LW1M-X	Φ137*159mm	1200 lm	36 V	25W	28W	90	4000K

Remark: X=F (ON-OFF) X=P (Phase Dim) X=A (1-10V Dim) X=D (DALI Dim) X=N (Without Driver)



SRW150/TRW150

Downlight / Wall Washer



Drawing

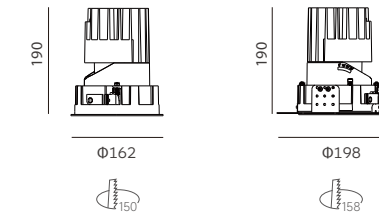

Order Options

25W 1000lm-1100lm		CITIZEN					
Code	Size	System LM	LED Voltage	LED W	System W	CRI	CCT
SRW150-CD930LW1M-X	Φ162*190mm	1000 lm	36 V	25W	28W	90	3000K
SRW150-CD940LW1M-X	Φ162*190mm	1100 lm	36 V	25W	28W	90	4000K

Remark: X=F (ON-OFF) X=P (Phase Dim) X=A (1-10V Dim) X=D (DALI Dim) X=N (Without Driver)

38W 1400lm-1500lm		CITIZEN					
Code	Size	System LM	LED Voltage	LED W	System W	CRI	CCT
SRW150-CF930LW1M-X	Φ162*190mm	1400 lm	36 V	38W	42W	90	3000K
SRW150-CF940LW1M-X	Φ162*190mm	1500 lm	36 V	38W	42W	90	4000K

Remark: X=F (ON-OFF) X=P (Phase Dim) X=A (1-10V Dim) X=D (DALI Dim) X=N (Without Driver)

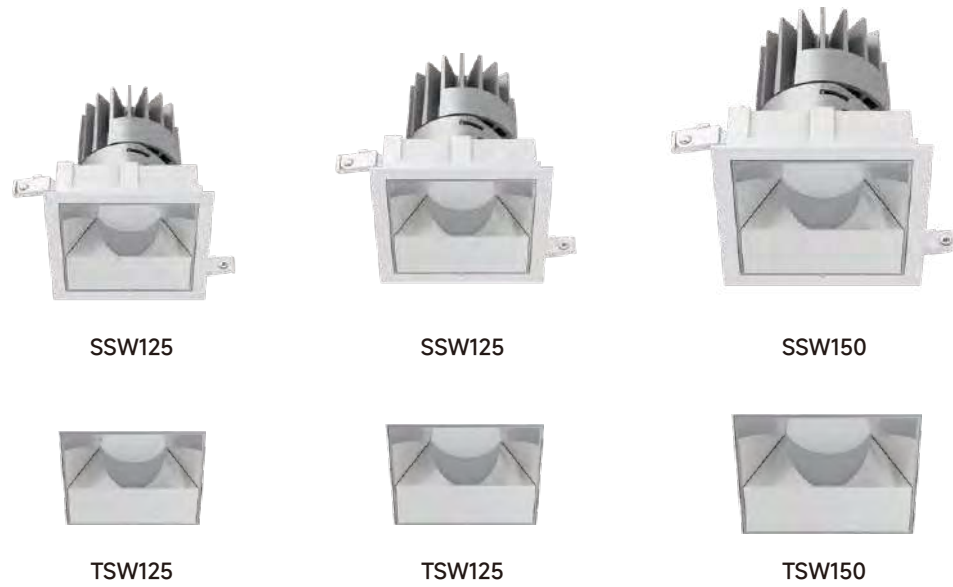

Downlight
SSW100/125/150



Features

- One light engine with various accessories.
- Easy to specify, easy to manage stock.
- Easy to install and adjust
- Easy to change reflector

Specifications

- Dimming modes: ON-OFF, Phase, 1-10V, Dali
- Beam angle: 20°, 40°, 50°
- Physical: Die-casting, wet painting
- Accessories: Honeycomb louver

Type

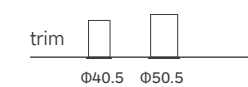

Light distribution

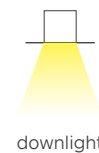

TRIM



TRIMLESS



SSW100/TSW100

Downlight / Wall Washer

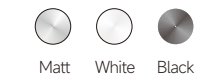

Drawing

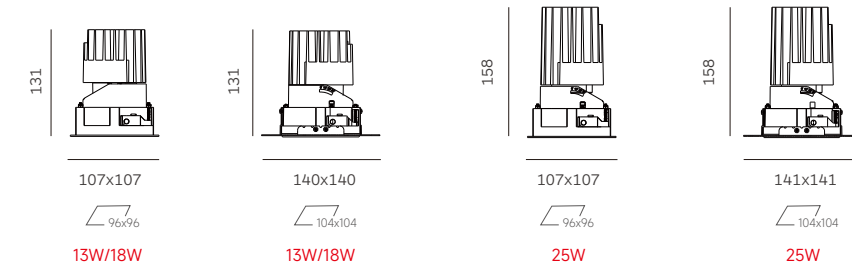

Order Options

13W 800lm-900lm		CITIZEN					
Code	Size	System LM	LED Voltage	LED W	System W	CRI	CCT
SSW100-CB930LW1M-X	107*131mm	800 lm	36 V	13W	15W	90	3000K
SSW100-CB940LW1M-X	107*131mm	900 lm	36 V	13W	15W	90	4000K

Remark: X=F (ON-OFF) X=P (Phase Dim) X=A (1-10V Dim) X=D (DALI Dim) X=N (Without Driver)

18W 1100lm-1200lm		CITIZEN					
Code	Size	System LM	LED Voltage	LED W	System W	CRI	CCT
SSW100-CC930LW1M-X	107*131mm	1100 lm	36 V	18W	21W	90	3000K
SSW100-CC940LW1M-X	107*131mm	1200 lm	36 V	18W	21W	90	4000K

Remark: X=F (ON-OFF) X=P (Phase Dim) X=A (1-10V Dim) X=D (DALI Dim) X=N (Without Driver)

25W 1100lm-1200lm		CITIZEN					
Code	Size	System LM	LED Voltage	LED W	System W	CRI	CCT
SSW100-CD930LW1M-X	107*158mm	1100 lm	36 V	25W	28W	90	3000K
SSW100-CD940LW1M-X	107*158mm	1200 lm	36 V	25W	28W	90	4000K

Remark: X=F (ON-OFF) X=P (Phase Dim) X=A (1-10V Dim) X=D (DALI Dim) X=N (Without Driver)



SSW125/TSW125

Downlight / Wall Washer



Drawing

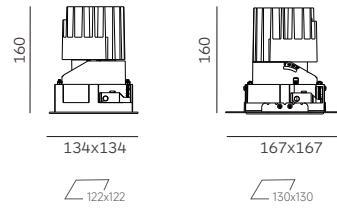

Order Options

18W 800lm-900lm		CITIZEN					
Code	Size	System LM	LED Voltage	LED W	System W	CRI	CCT
SSW125-CC930LW1M-X	134*160mm	800 lm	36 V	18W	21W	90	3000K
SSW125-CC940LW1M-X	134*160mm	900 lm	36 V	18W	21W	90	4000K

Remark: X=F (ON-OFF) X=P (Phase Dim) X=A (1-10V Dim) X=D (DALI Dim) X=N (Without Driver)

25W 1100lm-1200lm		CITIZEN					
Code	Size	System LM	LED Voltage	LED W	System W	CRI	CCT
SSW125-CD930LW1M-X	134*160mm	1100 lm	36 V	25W	28W	90	3000K
SSW125-CD940LW1M-X	134*160mm	1200 lm	36 V	25W	28W	90	4000K

Remark: X=F (ON-OFF) X=P (Phase Dim) X=A (1-10V Dim) X=D (DALI Dim) X=N (Without Driver)

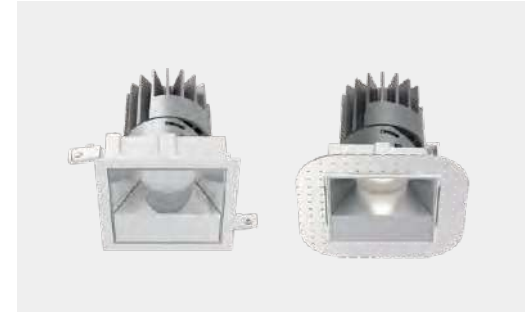

SSW150/TSW150

Downlight / Wall Washer



Drawing

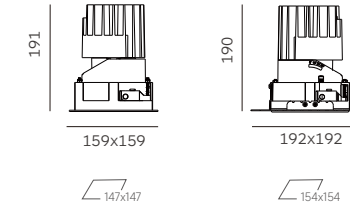

Order Options

25W 1000lm-1100lm		CITIZEN					
Code	Size	System LM	LED Voltage	LED W	System W	CRI	CCT
SSW150-CD930LW1M-X	159*191mm	1000 lm	36 V	25W	28W	90	3000K
SSW150-CD940LW1M-X	159*191mm	1100 lm	36 V	25W	28W	90	4000K

Remark: X=F (ON-OFF) X=P (Phase Dim) X=A (1-10V Dim) X=D (DALI Dim) X=N (Without Driver)

38W 1400lm-1500lm		CITIZEN					
Code	Size	System LM	LED Voltage	LED W	System W	CRI	CCT
SSW150-CF930LW1M-X	192*190mm	1400 lm	36 V	38W	42W	90	3000K
SSW150-CF940LW1M-X	192*190mm	1500 lm	36 V	38W	42W	90	4000K

Remark: X=F (ON-OFF) X=P (Phase Dim) X=A (1-10V Dim) X=D (DALI Dim) X=N (Without Driver)